



## SPD with Thermally Protected MOVs for Switchboards & Panelboards

## Product Number Configuration Guide

Product Number Example:



Application Specific Model Number:

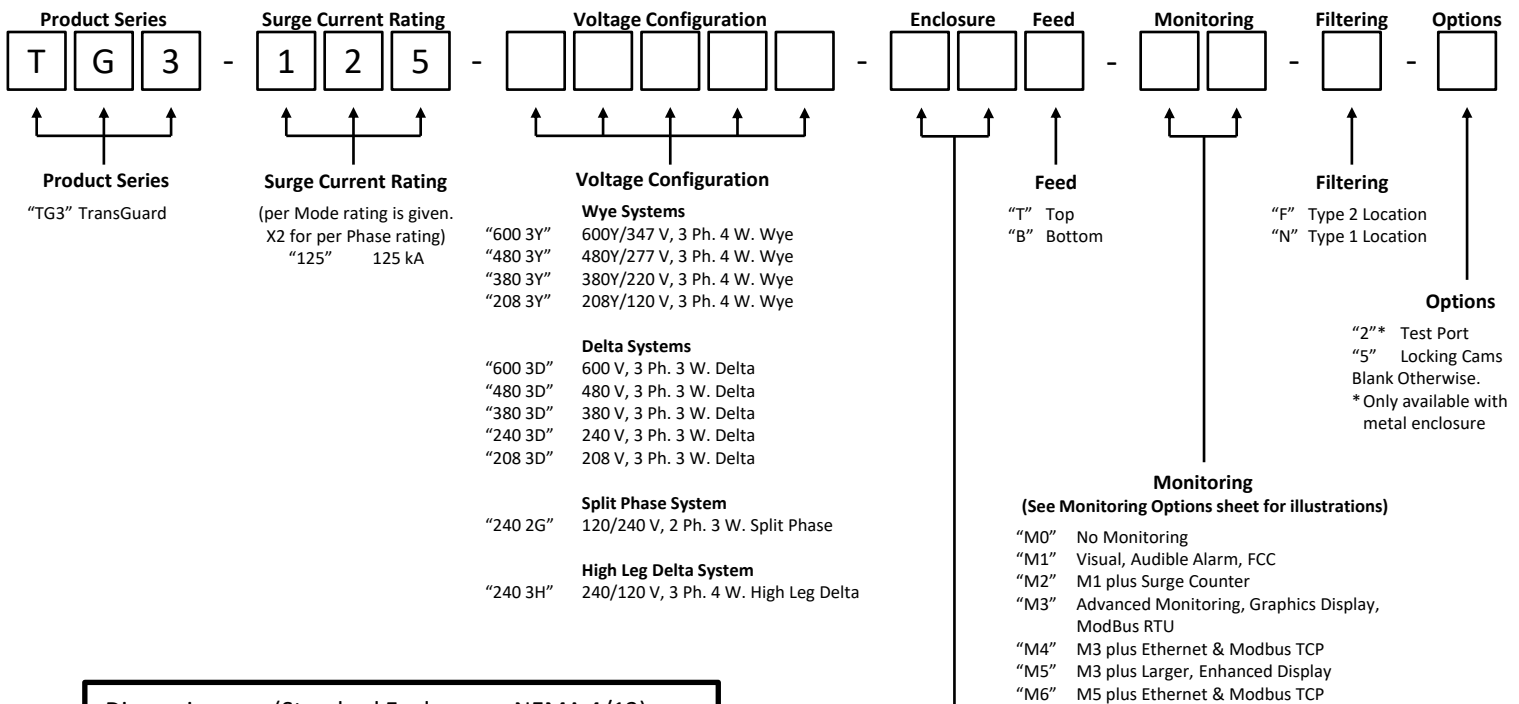

Dimensions	(Standard Enclosures: NEMA 4/12)
	<b>Metal Enclosure</b>
TG3-125:	24"h x 16"w x 9.20"d 50 lbs.
	<b>Plastic Enclosure</b>
TG3-125:	16.75"h x 14.75"w x 6.7"d 24 lbs.